

**DISTINTA SEZIONI CORNICE
FRAME PARTS DETAILS**

MOBILE SCREEN

250x156

16/10

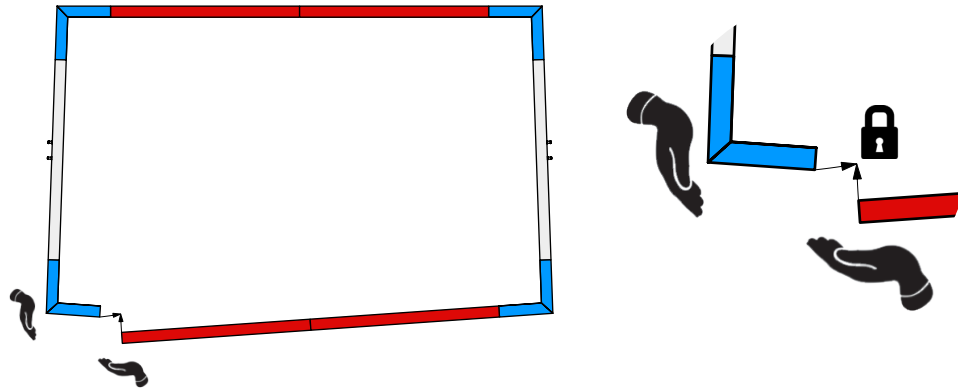

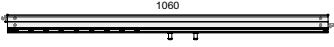
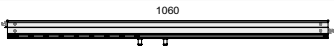
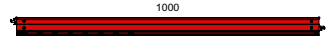
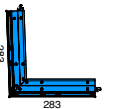
	x1	Vertical 1060 DX
	x1	Vertical 1060 SX
	x4	Horizontal 1000
	x4	Corner 283

Qualora i lati orizzontali dello schermo siano composti da sezioni di cornice di lunghezza diversa, l'ordine di montaggio di tali sezioni può essere modificato a piacimento.

In case the horizontal sides of the screen are composed by sections of different width, the mounting sequence of the sections may be varied as desired.

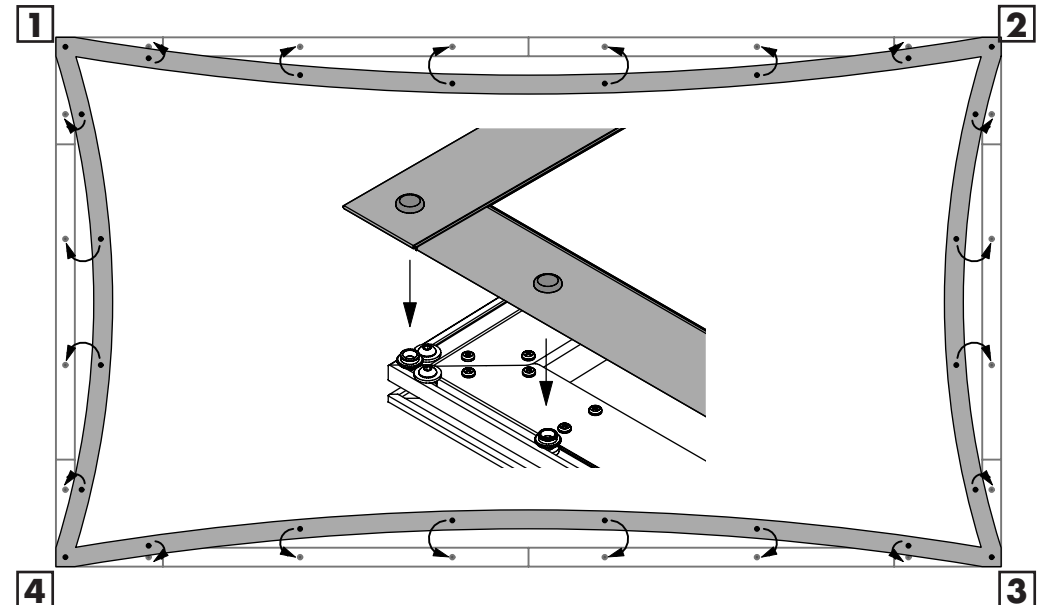
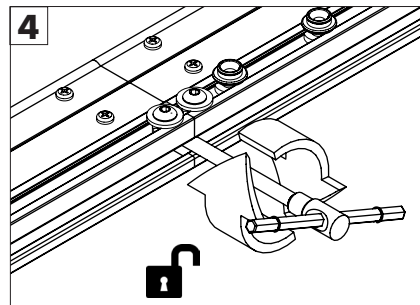
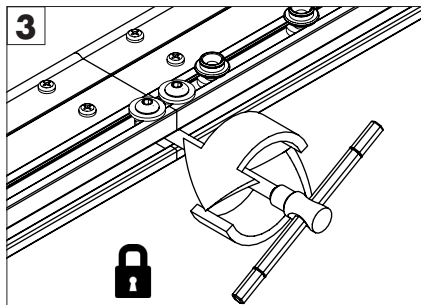
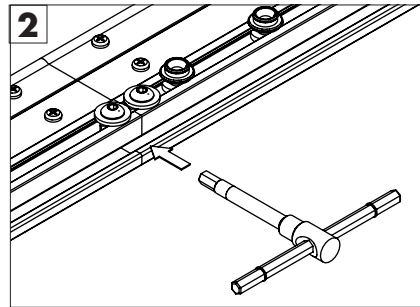
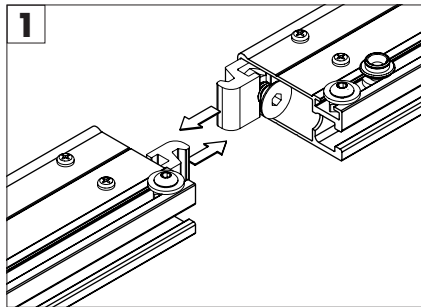

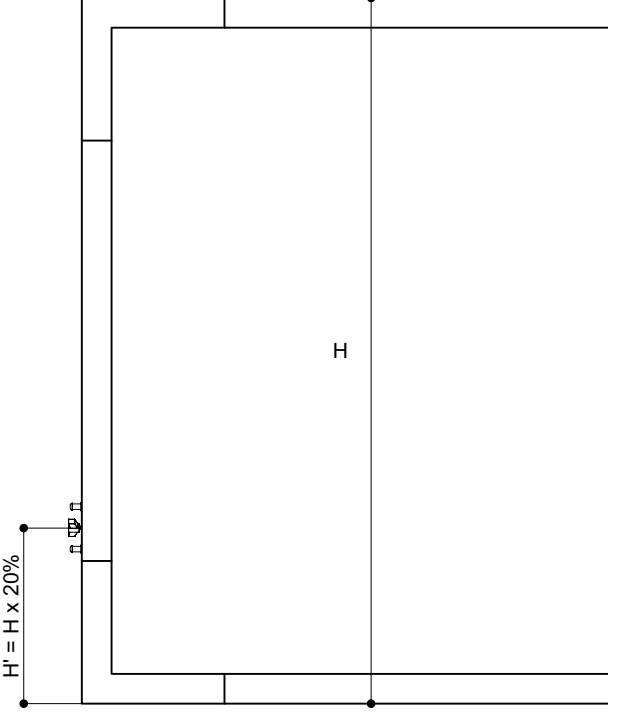
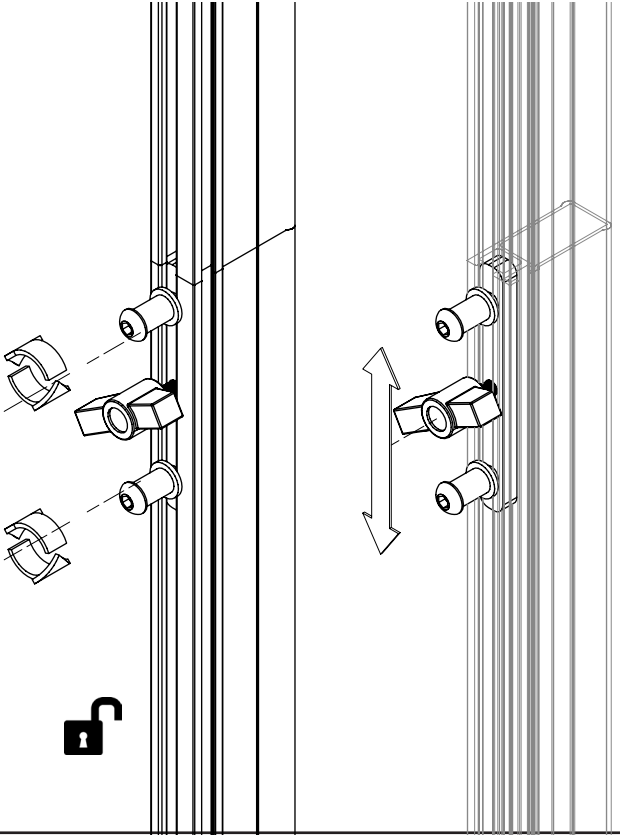
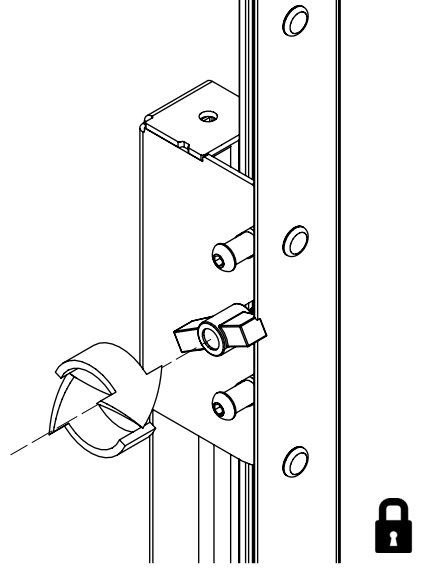
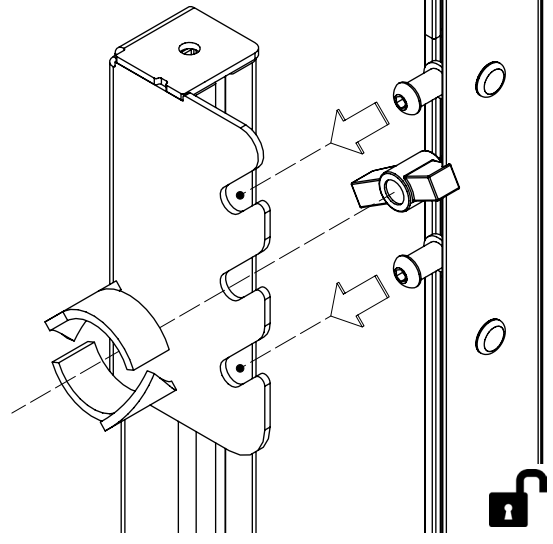
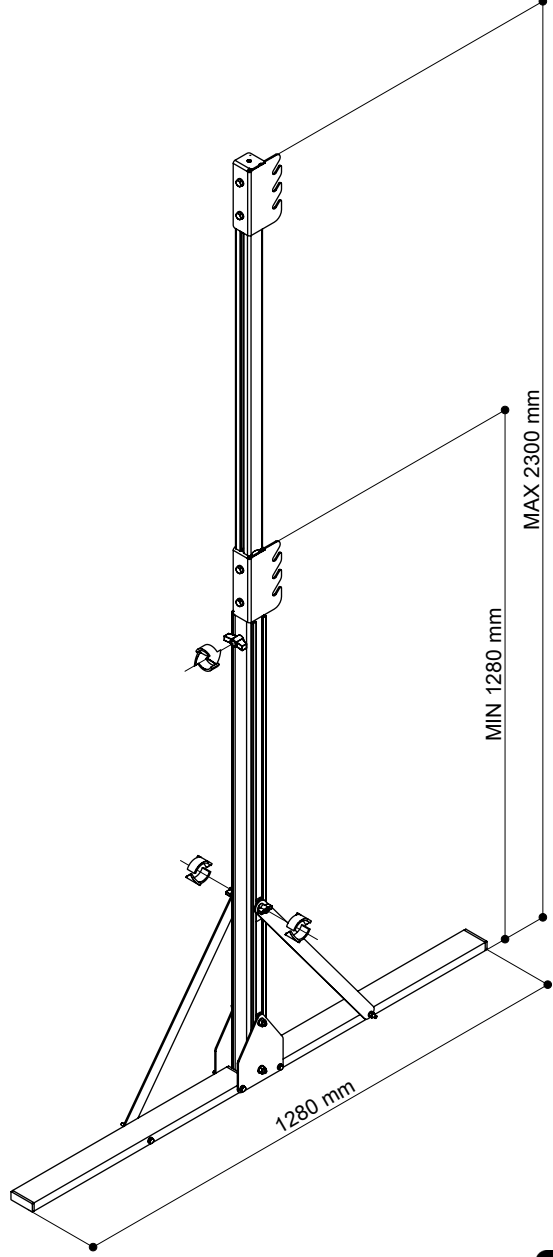
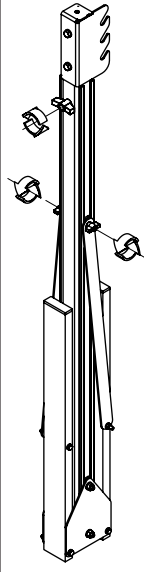

1

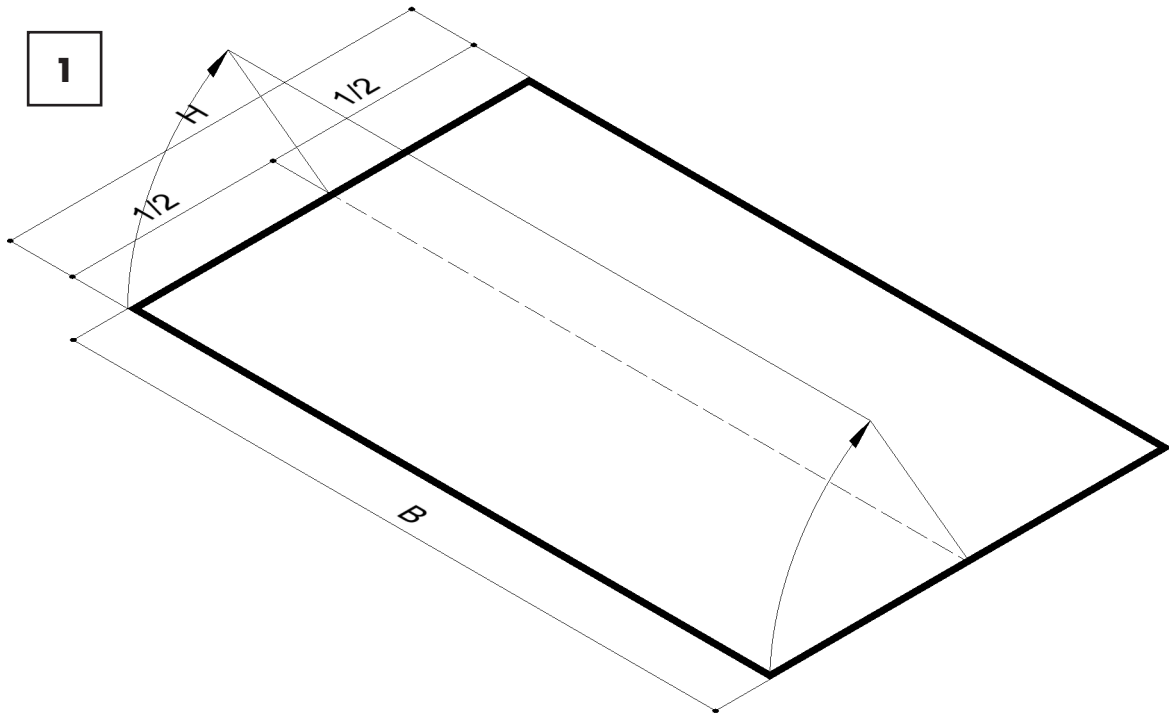

2

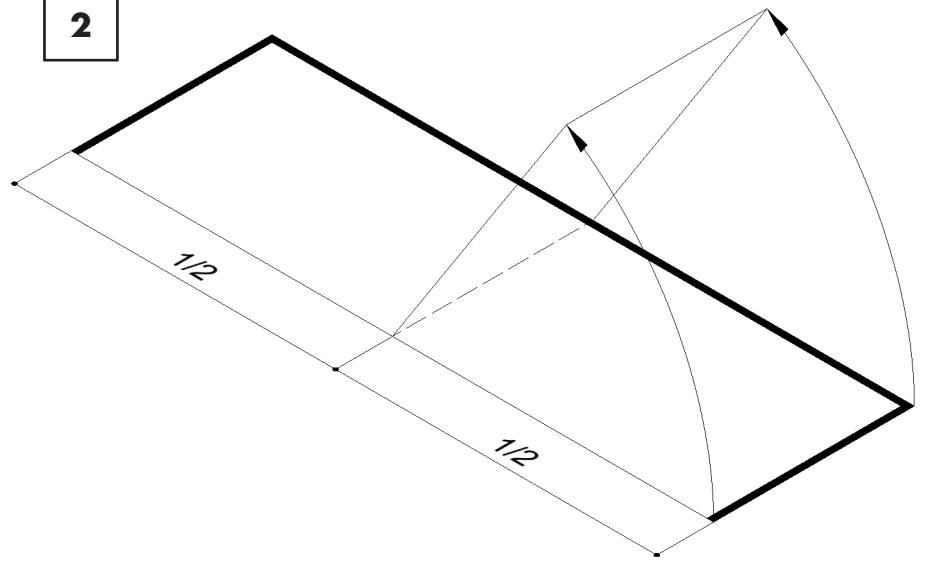

3

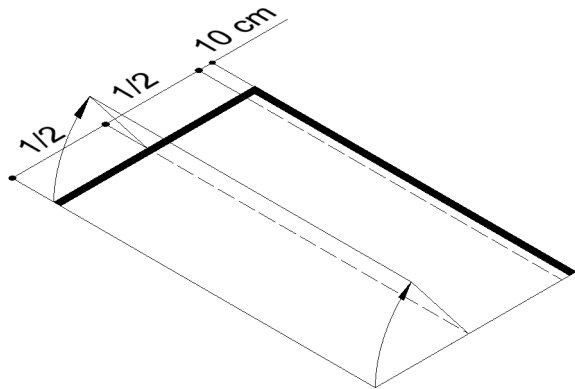

4

