

# SCREEN WINCH SYSTEM INSTALLATION MANUAL

## FOR SCREENS UP TO 300 cm. of width (MAR-2023)

Before installing the screen winch system, please read the following instructions carefully:



- **The screen winch system must be used INDOORS ONLY.**
  - **The screen winch system must be installed by qualified personnel only.**
  - **AFTER UNPACKING THE SCREEN WINCH TAKE CARE THAT AFTER RELEASING THE PACKAGING FOAM FROM THE TRACTION STEEL CABLES, YOU HAVE TO MOUNT THE PROJECTION SCREEN UNDER THE STEEL CABLES. THIS IN ORDER TO PREVENT THAT THE STEEL CABLES RAVEL UP INSIDE THE WINCH HOUSING.**
  - **NEVER CONNECT MORE THAN ONE MOTOR TO THE SAME SWITCHER. USE THE SUPPLIED SWITCHER ONLY.**
  - **NEVER CONNECT SCREEN WINCH MOTOR AND SCREEN MOTOR TO THE SAME SWITCHER.**
  - **IN CASE OF MAINTENANCE, UNPLUG THE POWER SUPPLY.**
  - **In case the SCREEN is controlled via optional interfaces:**
    - **The optional interfaces has to be supplied by ScreenInt or by a well-known tubular motor manufacturer**
    - **Take care that the control system is programmed so there is no tension on the interface output for at least 1 sec. during switching between rolling up and rolling down operations and viceversa.**
  - **IT IS FORBIDDEN TO OPERATE SCREEN WINCH SYSTEM AND PROJECTION SCREEN SIMULTANEOUSLY (RISK OF PERMANENT DAMAGES TO BOTH MOTORS).**
- ACTIVATION OF SCREEN WINCH SYSTEM AND PROJECTION SCREEN:**
- A – ROLL DOWN**
- **ROLL DOWN FIRST THE SCREEN WINCH UNIT TILL THE DESIRED HEIGHT AND CUT THE POWER TO THE SCREEN WINCH MOTOR.**
  - **ROLL DOWN THE PROJECTION SCREEN TILL ITS BOTTOM END STOP AND THEN CUT THE POWER TO THE SCREEN MOTOR.**
- B – ROLL UP**
- **ROLL UP FIRST THE PROJECTION SCREEN AND THEN CUT THE POWER TO THE SCREEN MOTOR.**
  - **THEN ROLL UP THE SCREEN WINCH UNIT TILL ITS CLOSED POSITION AND CUT THE POWER TO THE SCREEN WINCH MOTOR.**
- **Incorrect use of the screen winch system, including exceeding the maximum lifting weight of 60 kg., would be dangerous and invalidates the warranty.**
  - **Do not try to disassemble the screen winch or to paint the housing, as these operations will invalidate the warranty. In case you need a different housing colour, please check with ScreenInt as we have this option available.**
  - **Half-yearly and yearly the screen winch system has to be checked. Please see check register at page 10 of this document.**
  - **In addition to manufacturer inspection guidelines, we recommend you check your countries own legal obligations for checking and testing of lifting equipment.**
  - **It is forbidden to stay under the screen winch system.**
  - **For any repairing, please contact directly the dealer you purchased the unit from.**

The manufacturer and his agents do not take responsibility for any damage to property or personal injury if the winch is installed/used outside of recommended specifications.



This product uses a 230 V AC motor. DO NOT attempt to carry out repairs to the motor, there are no user serviceable parts.

Incorrect servicing could lead to risk of electric shock. For any repairing, please contact directly the dealer you purchased the unit from. In the event of a fault please contact the dealer /supplier. Warranty is 24 months Return To Base.

The screen winch system is  certified.

## WARRANTY CONDITIONS

This screen winch system is guaranteed 2 years from the purchase date for manufacturing defects and 5 years on motor defects.

Responsibility is limited to repairing or substitution of the defected components and without any other charge at our expense.

Warranty is officially voided if the screen winch has been dismantled or it is returned with collision damage or defective due to incorrect installation. Repairs must be carried out by an Approved ScreenInt Certified Engineer.

Warranty is officially voided if (all the following cases are including but not limited):

- 1) defects not due to deficiencies in the material or workmanship;
- 2) amendments, alterations, repairs or disassembling of the Product not previously authorized in writing by Screenint;
- 3) installation, use or maintenance of the Product not in compliance with Screenint 's instructions as set forth in this Installation Manual and/or in any other technical documentation supplied together with the Product;
- 4) bad and/or improper and/or not in compliance installation, maintenance, negligence, improper use;
- 5) use of non-original spare parts or not authorized in writing by Screenint;
- 6) normal wear and tear;
- 7) the motor is removed / dismantled;
- 8) the screen winch system has been damaged in transit;
- 9) the instructions regarding the electrical connections have not been followed;
- 10) the products have to be installed following the electric regulations (CEI) and the other local specific laws;
- 11) in the installation are used electric interfaces that does not allow the correct time lapse between up and down operation (complete cut down of electric power on both phases for one second)
- 12) electrical accessories have been used that are incompatible with the winch motor causing damage to its internal components;
- 13) the sticker regarding the serial number of the product has been altered, deleted, removed or tampered.

## TECHNICAL SPECIFICATIONS

Motor: Power 80 Nm  
Speed 12 rpm  
Consumption 360 W

Roll down speed: 19 sec. per metre

Net weight of the Screen Winch System: kg. 40

Maximum roll down stroke: 7 mt.

Maximum load that can be hung to the Screen Winch System: kg. 60

## SUPPLIED EQUIPMENT LIST:

When you open the packaging, please **CHECK** that it contains **ALL** the components below:

1. 1x SCREEN WINCH SYSTEM
2. 1x RF REMOTE CONTROL
3. 1x CABLE COILER

4. 1x SAFETY SYSTEM
5. 3x FIXING BRACKETS FOR FIXING THE SCREEN WINCH TO THE CEILING
6. 2x MOUNTING PLATES
7. 1x "L" SHAPE BRACKET FOR MOUNTING THE CONNECTOR BOX
8. 1x CONNECTOR BOX
9. 1x INSTALLATION MANUAL

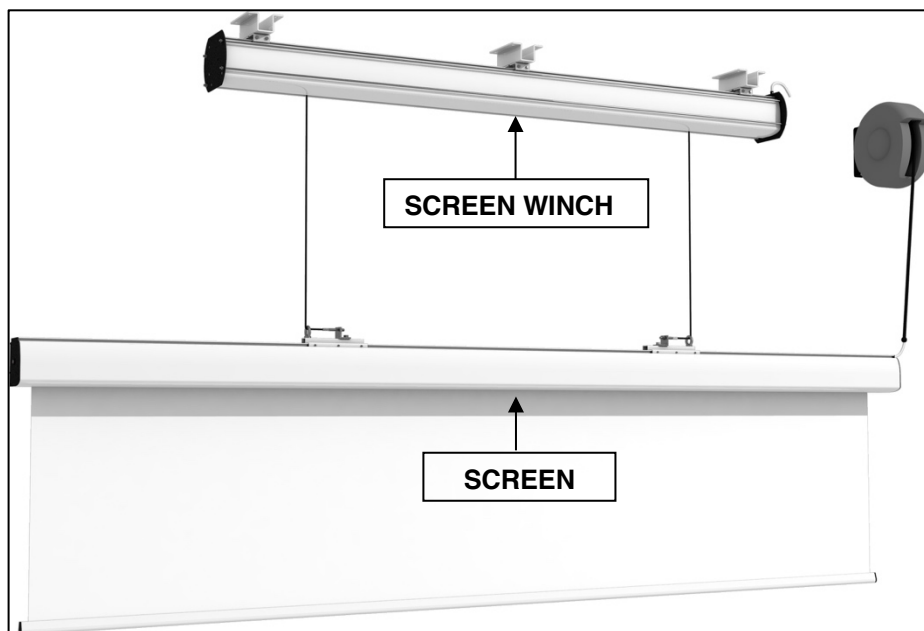

**Fig. 1**

This Screen Winch System is made to lift the screens models COMPACT – MAJOR – ELLIPSE and E-LITE manufactured by Euroscreen SRL.

In order to mount this winch system and the projection screen, please read **carefully** the following instructions:

1. First of all fix to the ceiling the 3 brackets for the screen winch, taking care that these 3 brackets are perfectly aligned and also mounted horizontally. From the central bracket, the left and right brackets have to be mounted at 98 cm distance from the central bracket. (see Fig. 1). Each bracket has to be mounted to the ceiling like showed in Fig. 2 with 4 suitable screws or bolts (**fixings are not supplied**).
2. Fix the screen winch (seen from the front with the power cable at the right side of the housing) at the brackets as shown in Fig. 3. First move the clamps close to the winch housing and tighten the nuts inside the bracket as shown in Fig. 3. Now in order to secure the clamps, tighten the 2 front screws of the bracket like shown in Fig. 4



**Fig. 2**



**Fig. 3**

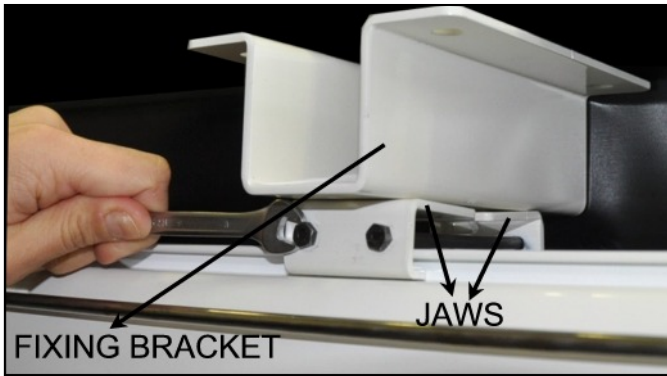
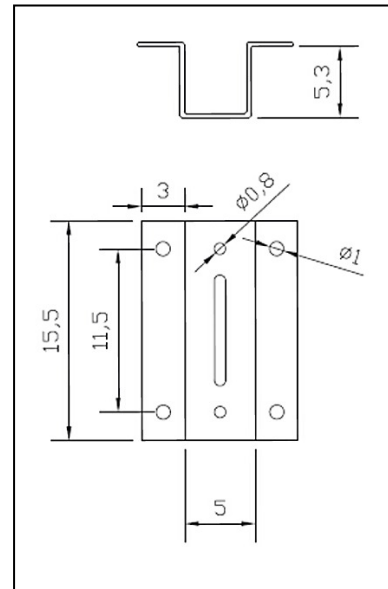

Fig. 4



Drawing of the bracket for fixing the screen winch system to the ceiling



Fig. 5

3. Fix the safety system (Fig. 5) to the left hand side of the screen winch housing, as in pictures below. For fixing it you will need to use the four bolts supplied with the suitable Allen key (not supplied), taking care that "TOP" is at the top side of the screen housing.

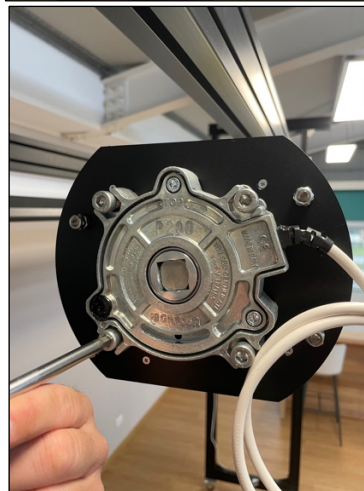
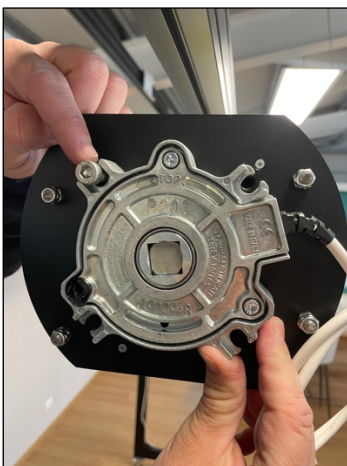
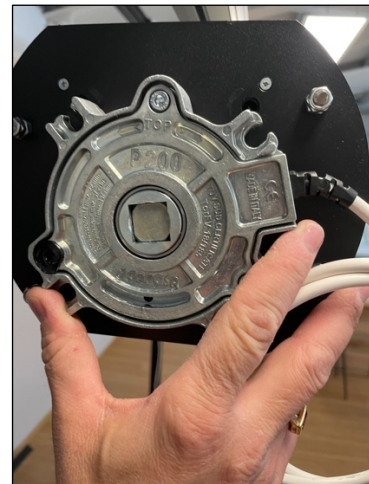
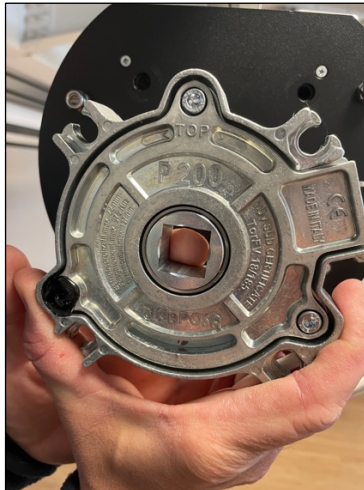
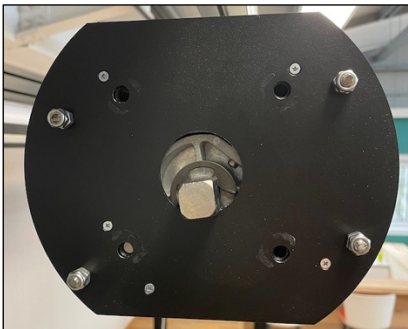

**Video Tutorial for fixing the safety system available on ScreenInt You Tube channel:**

<https://www.youtube.com/channel/UC- 2ddxaJHoCZKHBYvv6odQ>

**WARNING:**

**AFTER UNPACKING THE SCREEN WINCH TAKE CARE THAT AFTER RELEASING THE PACKAGING FOAM FROM THE TRACTION STEEL CABLES, YOU HAVE TO MOUNT THE PROJECTION SCREEN UNDER THE STEEL CABLES. THIS IN ORDER TO PREVENT THAT THE STEEL CABLES RAVEL UP INSIDE THE WINCH HOUSING. BEFORE PROCEEDING WITH ELECTRIC CONNECTION, PLEASE CHECK THAT, INSIDE, THE HOUSING OF THE SCREEN WINCH SYSTEM, BOTH TRACTION STEEL CABLES ARE WELL POSITIONED IN THE SPLINES OF THE ROLLER TUBE.**

**4. ELECTRIC CONNECTION**

- The motor has the possibility to be controlled via the supplied handheld RF remote control or via wired low voltage contact closures.
- The motor has a six-core power cable. **NEVER CONNECT THE MAINS TO THE WIRES WHITE, WHITE-BLACK, WHITE-ORANGE.**
- Once the winch is mounted to the ceiling, connect the wires brown, blue and yellow/green to the mains, following the scheme shown in Fig. 4A;

The winch is supplied with a safety mechanism (Fig. 4B) with a double security system: first - this is a mechanic safety system that prevents the steel cable to unroll when the speed has reached 50 rpm; second – this is an electrical security system that disconnect the electrical connection of the motor if the force driven on the steel cable, caused by the falling down, is more than 503 Nm.

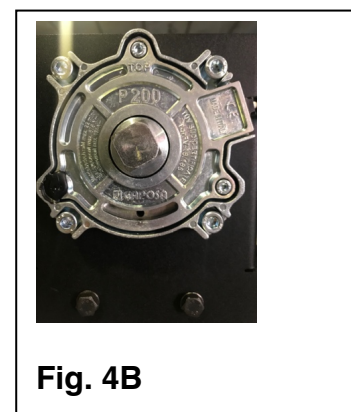
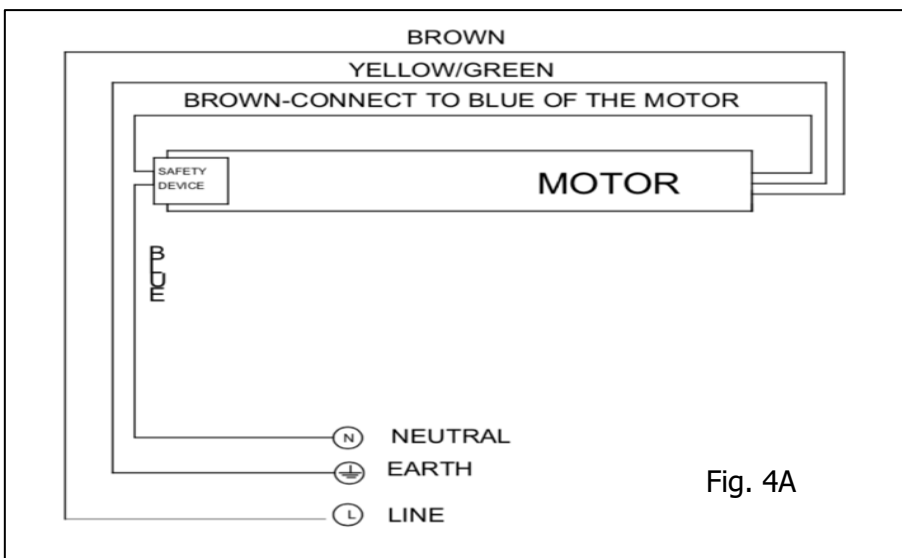

4. Unpack the screen and make a little sign exactly in the middle of the screen housing. Now mount one mounting plate at 65 cm. right from the middle point with the eyebolt at the right side and mount the other mounting plate at 65 cm. left from the middle point with the eyebolt at the left side (see Fig. 5).

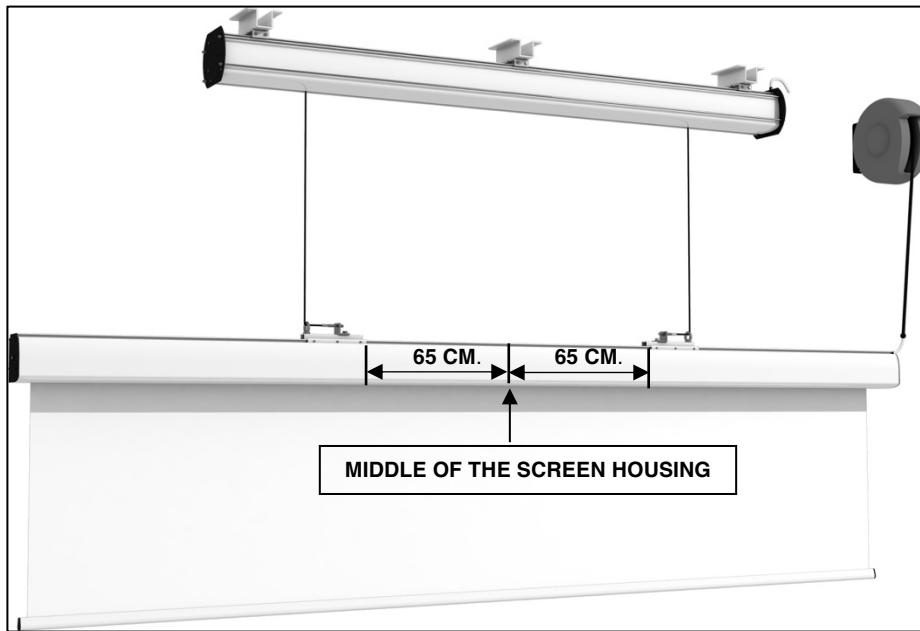

Fig. 5

5. With the winch completely rolled up, bring the screen housing under the screen winch and fix the right and left steel cables by the adjustment bolts through the eyebolts at the L-form brackets (see Fig. 6).

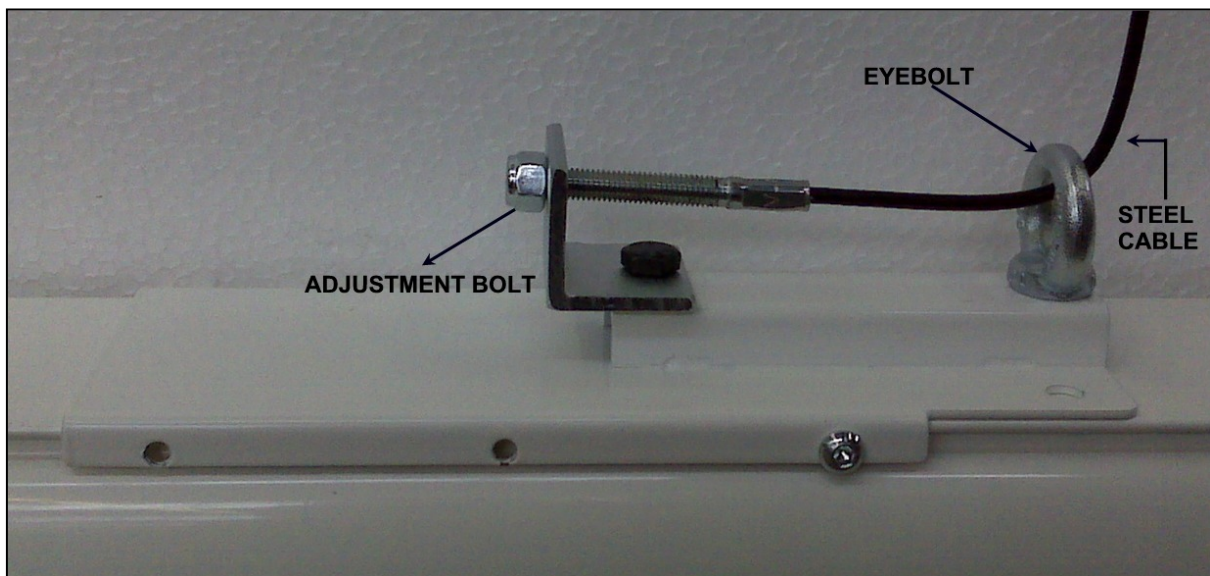

Fig. 6

6. Now check that the screen cabinet is perfectly levelled. In case not, please correct it by adjusting the bolt on the "L" form brackets.
7. To connect the mains 220V to the screen, you have to use the cable coiler that is included in the packaging. Mount the cable coiler (see Fig. 6B) to the ceiling behind the screen winch housing at the right side, using suitable screw anchors (**fixings are not supplied**).



**Fig. 6B – CABLE COILER**

8. Fix the connector box to the “L” shape bracket using the supplied screw and then, fix on the screen housing the “L” shape bracket as indicated in Fig. 7. Now fit the output power cable of the screen winch through the bracket and fix it with a wire clamp as shown in Fig.7 in order that it remains fixed when the screen housing moves up and down. Connect, inside the connector box, the end of output power cable of the cable coiler to the power cable that comes out of the screen housing (Fig. 8). At this step, you have to connect to the incoming power cable of the cable coiler fixed at the ceiling a plug and connect it with a switcher to the mains up in the ceiling.



**Fig. 7**



**Fig. 8**

**WARNING:** Once you have installed the product, when you switch on the Screen Winch System you will hear a rhythmical ticking which means that the safety device is working properly.





## END STOP ADJUSTMENT OF THE SCREEN WINCH

**WARNING: THE END STOP ADJUSTMENT HAS TO BE DONE CAREFULLY, OTHERWISE THE SCREEN WINCH CAN BE DAMAGED PERMANENTLY.**

**THE UPPER END STOP IS FACTORY PRESET AT THE HIGHEST POSSIBLE HEIGHT – DO NOT ATTEMPT TO RAISE IT MORE.**

**THE BOTTOM END STOP IS FACTORY PRESET AT A FEW CENTIMETRES OF DROP.**

**ON THE STEEL CABLE MOTOR HAND SIDE OF THE SCREEN WINCH SYSTEM, THERE IS, AT 680 CM. DROP, A WHITE TAPE WHICH INDICATES THAT THE WINCH HAS NEARLY REACHED THE MAXIMUM EXTENT, THEREFORE STOP IMMEDIATELY THE WINCH.**

**In case the bottom end stop is set lower than 7 mt., there is a DANGER OF FALLING DOWN OF THE PROJECTION SCREEN HOUSING AND PERMANENT DAMAGE OF THE SCREEN WINCH SYSTEM.**

In case, after installation, the end stops of the Screen Winch System need to be changed, please, proceed as follows:

### **A - SETTING OF THE LOWER END STOP (OPEN SCREEN WINCH SYSTEM)**

- Lower down the winch till half stroke, pressing the remote control button ▼ and stop it with button ■.
- Press the button ■ (for 5 secs) till the motor swivels 2 times.
- Press again the button ■ (for 5 sec) till the motor swivels 4 times.
- Press the button ▼ (for 5 sec) till the motor swivels 2 times.
- Press the buttons ▼ or ▲ in order to reach the desired position of the winch.  
Warning: during this programming operation you have to keep the buttons ▼ or ▲ pressed in order to reach the desired position.
- Once this position is reached, in order to memorize it press the button ■ (for 5 sec) till the motor swivels 3 times.

**In case of mistake, repeat the procedure.**

### **B- SETTING OF THE UPPER END STOP**

**WARNING:** in case the installer needs to modify this end-stop, it is ONLY allowed to lower the upper end-stop position. **Do not try to raise the upper end-stop because this will cause severe damages to the product and this operation will invalidate the warranty.**

- Lower down the winch till half stroke, pressing the remote control button ▼ and stop it with button ■.
- Press the button ■ (for 5 secs) till the motor swivels 2 times.
- Press again the button ■ (for 5 sec) till the motor swivels 4 times.

- Press the button ▲ (for 5 sec) till the motor swivels 2 times.
- Press the buttons ▼ or ▲ in order to reach the desired position of the winch.  
Warning: during this programming operation you have to keep the buttons ▼ or ▲ pressed in order to reach the desired position.
- Once this position is reached, in order to memorize it press the button ■ (for 5 sec) till the motor swivels 3 times.

**In case of mistake, repeat the procedure.**

### **C- USE OF THE REMOTE CONTROL**

- Press the button ▼ in order to reach the lower-end stop.
- Press the button ▲ in order to reach the upper-end stop.



**Fig. 7A**

### **D – CONNECTION OF LOW VOLTAGE CONTACTS TO REACH THE DIFFERENT END-STOPS**

- Close the connection, for at least 1 second, between the white-black and white-orange wires in order to reach the LOWER end stop.
- Close the connection, for at least 1 second, between the white-black and white wires in order to reach the UPPER end stop.

**DO NOT TRY TO HIGH UPPER END-STOP, OTHERWISE THE SCREEN WINCH SYSTEM CAN BE DAMAGED PERMANENTLY AND THE WARRANTY WILL BE VOIDED.**

**WARNING: do not change the end stops of the projection screen, otherwise you will invalidate the warranty on the screen.**

