

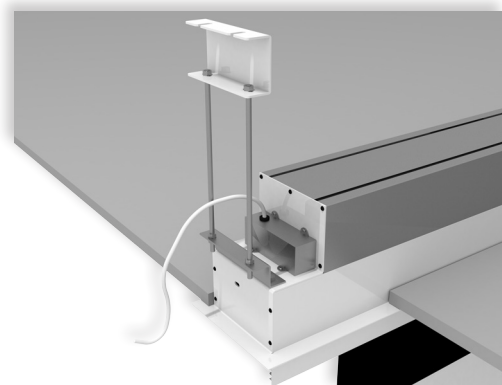





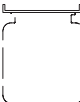

RAFFAELLO PROFESSIONAL is an in ceiling electric projection screen, that has an innovative mechanical construction which makes it an ideal and unique solution for residential and AV professional environments. Its peculiarity is that, **once mounted inside the false ceiling, the product is completely hidden** and no visible openings can be seen. The mechanism is composed by two silent and fast motors, one for the opening of the trap door and the other for rolling down of the projection screen. **IMPORTANT:** The structure allows substitution of the projection surface rolling pipe without the need to uninstall the product completely.

Available in 4:3, 16:9 and 16:10 formats or **bespoke sizes**.



LEFT SIDE VIEW (motor side)

- | | | | | | | |
|---|---|---|---|--|---|---|
|  |  |  |  |  |  |  |
| n.2 Ceiling mounting brackets | n.1 On/off switcher | Kit RF Remote control with external receiver | Interface switch 12 volt | Low voltage contact interface | Multiple control interface set | Interface RS485 |
| INCLUDED | | | OPTIONAL pag 70-71 | | | |



